

Features

- ◇ iBridge is an intelligent communications unit that stores and sends sensor samples from a wide selection of sensors
- ◇ Built-in wheatstone bridge electronics for strain-gauge support in quarter-, half-, and full bridge configuration.
- ◇ Internal temperature and accelerometer sensor
- ◇ Internal data pre-processing to reduce network usage
- ◇ Trigger functionality to sample faster in the event of a sensor reading outside preconfigured trigger levels
- ◇ Operating temperature -20°C to +50°C
- ◇ Internal cellular antenna
- ◇ Remote firmware updates and configuration of settings
- ◇ Transmits data to an online cloud-service, the sensor samples can be analysed and processed from all over the world.
- ◇ Data can be viewed through our portal, or fetched directly from our API
- ◇ Battery powered (or external 12-24V supply)
- ◇ IP67 enclosure

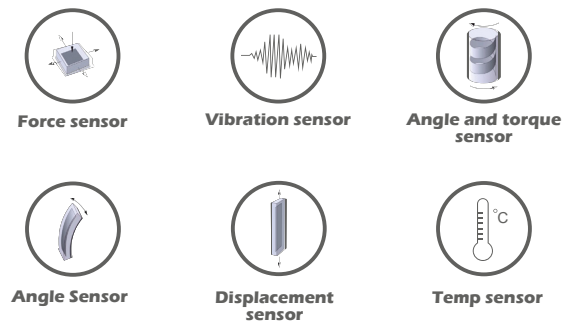

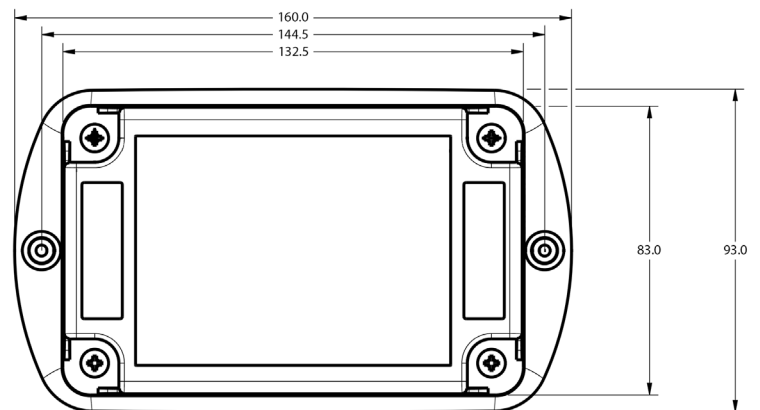

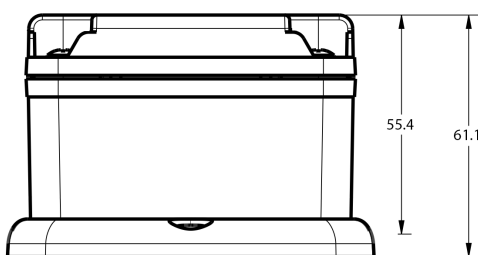







Dimensions



Specifications

Internal Sensors	
- Quarter, half, or full strain gage bridge input	Built in PGA, LP Filter, ADC 24 bit.
- Temperature measurement (internal)	Accuracy 0.5C
- 3-axis Accelerometer	+/- 2, 4, 8 and 16G
Data handling internal	
- Internal data pre-processing to reduce network data	
- Sampling configuration	Sample rate adjustment
- Internal memory keeping	128000 samples
- Strain gage resistance	1k to 10kΩ
- Measuring range	20mV/V
- Trigger modes (all channels)	none, min, max, min/max, slope
- Sample averaging	
Battery	
- Type	Saft LSH20 3,6V Lithiumbattery
- Battery life	>12 months (settings dependant)
External Sensors Supported	
- Sensors with 4-20mA current output	
- Sensors with 0-10V voltage output	
Communication Components	
- NB/CAT-M modem	4G with 2G fallback
- Internal antenna	
- Micro SIM card	
- Remote Data settings	
- Telemetry transfer protocol	MQTT
- Reporting battery voltage	
- Remote device configuration	
Physical characteristics	
- Enclosure	IP67
- Product dimensions	160 X 93 X 61.1 mm
- Regulatory compliance	CE (Europe)
- Operating temperature	-20°C to +50°C

Cable mapping

10-lead cable		
Red		+12V
Black		-12V
Yellow		Excitation voltage 3,3V (+)
Blue		Signal ground (-)
Gray		Sensor Channel 1 (+)
Green		Sensor Channel 2 (+)
Brown		Sensor Channel 3 (+)
White		Sensor Channel 3 (-)
Purple		Sensor Channel 4 (+)
Pink		Sensor Power out 12V (+)